

## **Effects of Exterior Insulation on Moisture Performance of Wood-Frame Walls in the Pacific Northwest: Measurements and Hygrothermal Modeling**

Samuel V. Glass<sup>1</sup>, Borjen Yeh<sup>2</sup>, and Benjamin J. Herzog<sup>3</sup>

<sup>1</sup> Research Physical Scientist, Building and Fire Sciences, USDA Forest Service Forest Products Laboratory, 1 Gifford Pinchot Dr., Madison, WI, 53726. (608) 231-9401, svglass@fs.fed.us.

<sup>2</sup> Director, Technical Services Division, APA – The Engineered Wood Association, 7011 S. 19th St., Tacoma, WA, 98466. (253) 620-7467, borjen.yeh@apawood.org.

<sup>3</sup> Manager, APA Laboratories, Technical Services Division, APA – The Engineered Wood Association, 7011 S. 19th St., Tacoma, WA, 98466. (253) 620-7498, ben.herzog@apawood.org.

### **ABSTRACT**

Continuous exterior insulation on above-grade walls is becoming more common in many parts of North America. It is generally accepted that exterior insulation provides advantages for energy performance, by reducing thermal bridging, and for moisture performance, by warming the wood structural members, thereby reducing the potential for wintertime moisture accumulation. However, the effects of vapor-tight rigid foam insulation on the drying capability of the wall systems are not fully understood. In this study, temperature and moisture conditions in north-facing and south-facing wall assemblies with vapor-open and vapor-tight exterior insulation were monitored in a natural exposure test facility in the Marine 4 Climate Zone over a two-year period. The wall assemblies included interior gypsum board with latex primer and paint, 2×4 framing with nominal R-13 batt insulation, 11 mm (7/16 in.) oriented strand board, nominal R-5 exterior insulation, and white-color vinyl siding. Exterior insulation was either extruded polystyrene or mineral wool. Measurements and hygrothermal simulations indicated that walls with extruded polystyrene and mineral wool exterior insulation in north and south orientations perform similarly. Moisture content in wood framing and oriented strand board were within safe levels.

### **INTRODUCTION**

Long-term moisture performance of exterior wall assemblies is a key consideration for contemporary energy-efficient housing. Designers and builders of wood-frame walls have a host of insulation materials and configurations to choose from. Continuous exterior insulation is becoming more common in many parts of North America. Although considerable research has been conducted on exterior insulation in wood-frame walls, further work is needed to provide a quantitative basis to minimize the risk of moisture performance and durability problems.

Climate characteristics can have a substantial influence on moisture dynamics in walls. Marine climates, as defined by Lstiburek (2004) and adopted by the U.S.

Department of Energy (n.d.), typically have cool, rainy winters and mild, dry summers. The moisture response of the building envelope depends on exposure to local environmental conditions, such as wind-driven rain, solar radiation, temperature, and humidity, as well as the interior humidity levels.

Moisture control strategies for exterior wall assemblies address the various sources of moisture interior and exterior of the building and the ways in which moisture migrates (TenWolde and Rose 1996). Exterior water management is critical to avoid bulk water intrusion. A continuous air barrier system minimizes moisture accumulation caused by uncontrolled air leakage. Vapor diffusion control strategies vary according to climate and properties of the materials in the assembly (Lstiburek 2004). In addition, wall assemblies should have the ability to dry out if they get wet (either during construction or during their service life). Drying potential is often a concern for wall assemblies that are insulated and air sealed to levels required by current model energy codes (Lstiburek 2013), such as the International Energy Conservation Code (IECC) (ICC 2015a). Drying potential depends not only on the configuration of the wall assembly but also on the climate. The marine climate of the Pacific Northwest has extremely low drying potential during the cool, rainy months (Desjarlais et al. 2001).

Continuous exterior insulation raises the temperature of wood structural members in exterior walls during cold weather, relative to walls without exterior insulation, thereby reducing the potential for wintertime moisture accumulation (Tsongas 1991, Straube 2011). This thermal effect reduces the vulnerability of the wall to water vapor migration from the interior carried either by air leakage or vapor diffusion. Exterior insulation materials of different types vary in vapor permeability; mineral wool, for example, is highly vapor-open whereas rigid foam insulation is typically vapor-tight. Vapor-tight exterior insulation may limit the outward drying potential of wall systems (Lstiburek 2013).

Hygrothermal modeling has been used to simulate drying of wall assemblies under specific climatic conditions. Smegal and Straube (2011) simulated the drying of plywood sheathing in 2×6 wood-frame walls in the climate of Portland, Oregon (zone 4C) with two types of exterior insulation. Walls with vapor-open mineral wool (MW) dried out faster than walls with vapor-tight extruded polystyrene (XPS). Glass (2013) found the same trend for 2×4 walls with oriented strand board (OSB) sheathing simulated in the mixed-humid climate of Baltimore, Maryland (zone 4A).

Two recent wall monitoring studies in the marine climate of the Pacific Northwest have investigated performance of exterior insulation in controlled test huts. Tichy and Murray (2007) examined a range of wood-frame walls with a test facility on the campus of Washington State University, located in Puyallup, Washington. They found that stucco-clad walls with 25 mm (1 in.) thick rigid XPS over OSB, 2×4 framing with nominal R-13 glass fiber batt insulation, and a “smart” vapor retarder resulted in lower moisture levels than a comparable wall without XPS but with 2×6 framing and R-21 batt insulation. The walls with XPS dried at a rate similar to the wall without XPS after the interior side of the OSB had been wetted with a controlled dose of water.

Smegal et al. (2013) compared three configurations of stucco-clad walls in a test hut in Coquitlam, British Columbia. All three configurations had OSB sheathing, 2×6 framing, and glass fiber batt cavity insulation. The first wall had stucco cladding installed over backerboard on 19 mm (3/4 in.) furring strips, creating a ventilated cavity. The second had the stucco cladding directly applied over a single layer of building paper. Both of these had an interior polyethylene vapor barrier. The third wall included 38 mm (1.5 in.) XPS to the exterior of the OSB sheathing with a corrugated housewrap between the two; this wall did not include interior polyethylene. Baseline OSB moisture contents were similar for the wall with ventilated stucco and the wall with XPS, but were considerably higher for the wall with direct-applied stucco. Controlled liquid-water wettings to the interior and exterior of the OSB sheathing were conducted five times over a period of two years. Following the interior wetting, the OSB sheathing in the wall with ventilated stucco and the wall with XPS dried at a similar rate, and both dried faster than the wall with direct-applied stucco. Following the exterior wetting events, the wall with ventilated stucco cladding dried more rapidly than the wall with XPS, which dried at a rate similar to the wall with direct-applied stucco. The wall with XPS, however, returned to a lower OSB moisture content than the wall with direct-applied stucco.

A joint research project was initiated in 2011 by APA – The Engineered Wood Association and the USDA Forest Products Laboratory to study the structural and hygrothermal performance of wood-frame walls with wood structural panel sheathing and rigid foam insulation (Yeh et al. 2014). This project builds on the studies discussed above by comparing 2×4 walls with no interior vapor retarder (other than latex paint) but with two types of exterior insulation: vapor-open MW and vapor-tight XPS. The project included two phases of hygrothermal monitoring in the Marine 4 climate zone. Phase I was conducted from February 2012 through February 2013 and Phase II from March 2013 through July 2014. An artificial water injection into the wall cavity was introduced in Phase II to simulate water leakage and to evaluate the rate of drying under natural conditions. This paper summarizes the project and additionally evaluates the capability of hygrothermal modeling software to predict the moisture performance of the wall systems.

## **EXPERIMENTAL METHODS**

The evaluation of full-scale wall assemblies was conducted at the Natural Exposure Testing (NET) facility located on the Washington State University Agriculture Research campus in Puyallup, Pierce County, Washington (Tichy and Murray 2007). This location is classified as the Marine 4 climate zone (or 4C) in accordance with the IECC. The facility is about 15 km southeast of Tacoma, Washington.

**Description of test facility.** The NET facility was located to provide maximum exposure of test walls facing south and north. South-facing walls receive the highest exposure to wind-driven rainfall, which occurs primarily in autumn and winter. North-facing walls are exposed to limited wind-driven rain but lack direct exposure to sun in the winter, setting up an alternative critical condition. The building is in an open field with no obstructions within 400 m (1300 ft) of the south-facing wall. To the north, there are a few one-story buildings located 60 m (200 ft) or more away.

The NET facility is a 4.3 m × 21 m (14 ft × 70 ft) one-story building designed using open beam construction to maximize openings for test walls in segments (Figure 1). Each long side features 12 pairs of 1.2 m (4 ft) wide by 2.7 m (9 ft) high bays for installation of test wall sections. A 2 ft high insulated knee wall was poured with a slab on grade. The building's structural frame was constructed with structural insulated panels (SIPs). Two 10.7 m (35 ft) long structural composite lumber (SCL) beams were used to support the roof panels. SIP construction was used to facilitate air tightness and provide required insulation performance. Roof overhangs were limited to approximately 250 mm (10 in.) to allow appreciable exposure of the test walls to the weather. Gutters were provided to collect run-off rain water from the roof.

The NET facility is segmented into two 4.3 m × 10.7 m (14 ft × 35 ft) rooms with temperature and humidity control systems for each. This was done to allow creation of different interior environments in each of the two rooms when necessary. Each room is equipped with an independent electric heating unit, wall mount air conditioner, and humidifier/dehumidifier. A plan view of the building is shown in Figure 1 and the southwest elevation is pictured in Figure 2.

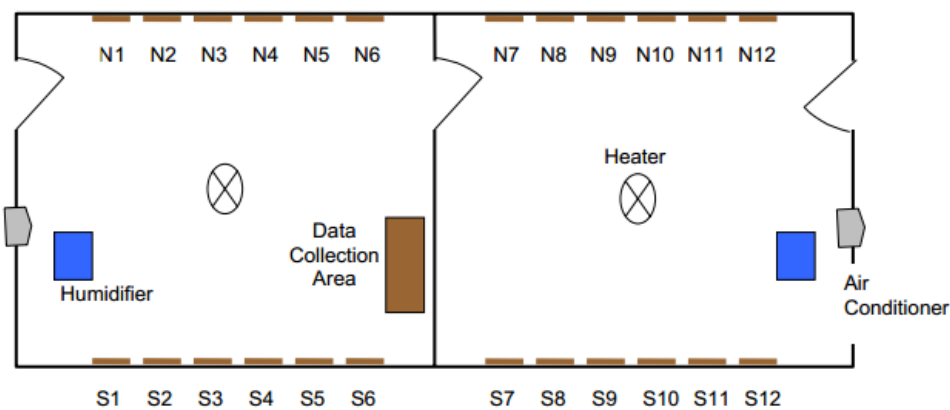

**Figure 1. Floor plan of the NET facility**



**Figure 2. NET facility viewed from the southwest**

**Wall configurations.** Two primary wall configurations were monitored for this study, each duplicated in north and south orientations (Table 1). The four wall assemblies were constructed based on a 4-foot by 9-foot design using standard 38 mm × 89 mm (nominal 2×4) kiln-dried Douglas-fir dimension lumber. The walls included a double top plate and a single bottom plate placed on a floor plate and rim board. This frame design provides two 368 mm × 2.32 m (14.5 in. × 91.5 in.) primary wall cavities that are protected from edge effects by smaller buffer cavities (Figure 3). The floor plate was insulated to the interior to separate the bottom plate of the test wall from the foundation.

**Table 1. Test wall configurations**

Wall	Orientation	Exterior Insulation	Water-Resistive Barrier
N7 S11	North South	25 mm (1 in.) XPS <sup>a</sup>	Taped XPS
N8 S12	North South	32 mm (1.25 in.) MW <sup>b</sup>	Spun-bonded polyolefin housewrap

<sup>a</sup> Extruded polystyrene

<sup>b</sup> Mineral wool

All assemblies had structural panel sheathing on the exterior of the framing consisting of 11 mm (7/16 in. Performance Category) OSB made primarily from aspen. Wall cavity insulation was glass fiber batt insulation with no facing in all cases; nominal thermal resistance was 2.3 m<sup>2</sup>·K/W (13 h·ft<sup>2</sup>·°F/Btu) for 89 mm (3.5 in.) thickness. All walls had 12.5 mm (1/2 in.) interior gypsum board, which was finished with one coat of latex primer and two coats of latex paint. None of the walls had any additional interior vapor retarder. Use of latex paint for interior vapor control in walls with sufficient exterior insulation is permitted by the International Residential Code (IRC) (ICC 2015b), which considers latex paint a Class III vapor retarder, having a dry cup vapor permeance in the range from 57 to 570 ng/(Pa·s·m<sup>2</sup>) (1 to 10 perms) (Lstiburek 2004).

For the walls constructed with mineral wool exterior insulation, a spun-bonded polyolefin house wrap was applied to the OSB sheathing prior to installation of the MW insulation. For the walls with XPS exterior insulation, no house wrap was applied; the joints between XPS rigid boards were taped with sheathing tape on the exterior surface to function as the water-resistive barrier. All walls were clad with vinyl siding, white in color, which was fastened through the exterior rigid insulation into the wood studs.

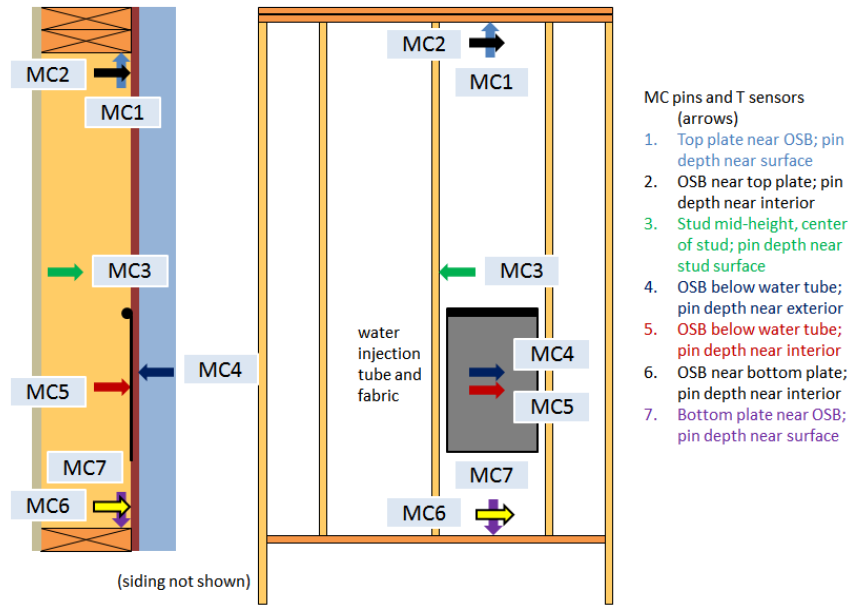

**Figure 3. Placement of moisture content/temperature sensors**

**Wall assembly instrumentation.** A data acquisition system was installed to monitor the hygrothermal performance of the test walls as well as indoor and outdoor environmental conditions. Sampling occurred every 5 minutes and values were averaged hourly.

Wood moisture content (MC) was measured in the framing and OSB sheathing at seven locations (Figure 3). Each location had a pair of moisture pins (brass nails) installed in the wood member 25 mm (1 in.) apart to obtain an electrical conductance reading related to substrate moisture content. The nails were coated with an electrical insulating coating to limit the measurement to the tip of the sensor. Pin pairs were typically inserted to a depth of 3 mm (1/8 in.) with the exception of the pair that was inserted to reach 3 mm (1/8 in.) from the exterior surface of the OSB.

Each moisture pin pair was partnered with a temperature sensor (thermistor) with an accuracy of 0.2°C (0.36°F). All moisture content readings were corrected for temperature and species based on Straube et al. (2002). The measurement uncertainty was estimated to be ±2% MC between 10% and 25% MC.

Relative humidity (RH) levels were also measured using capacitance-type humidity sensors at six locations in each wall assembly, with temperature sensors at the same locations. Further detail on these measurements can be found in the project report (Yeh et al. 2014).

**Water injections.** To provide additional field data on the drying performance of the test walls, Phase II of this study (March 2013 through July 2014) included simulated water leakage into the wall cavities. A method based on prior NET facility research experience was used (Tichy and Murray 2007). The method employed irrigation tubing and a medium that would retain water, located on the interior side of the OSB

sheathing in each wall cavity, as shown in Figure 3. The process of injecting water into the wall cavities, however, was found to be less reliable than anticipated. In some cases the medium did not retain all of the water injected through the tubing, and water ran down to the bottom plate.

Over the test period, two targeted water injection periods were conducted. The first series of injections was performed from March 25, 2013, to March 29, 2013. Injections of 60 mL of water were made each day, resulting in a total of 300 mL on each wall over the course of five days. The second series of injections was performed from January 20, 2014, to January 24, 2014. 50 mL of water was injected into each of the walls in the morning and afternoon (total of 100 mL) each day for four days, followed by a single morning injection of 50 mL on the fifth day, resulting in a total of 450 mL for each wall over the course of five days.

**Interior and exterior environmental conditions.** A weather station was mounted on the test facility at the southwest corner (Figure 2). The station included an anemometer to measure wind speed and direction, a temperature and humidity sensor, a tipping-bucket rain gauge for vertically falling precipitation, and a horizontally installed pyranometer to measure solar radiation. Two additional vertically positioned pyranometers were installed on the north and south walls of the test facility to monitor solar radiation at the wall surfaces.

Exterior temperatures measured onsite were roughly similar to historical average values (Figure 4). Some summer months were warmer than average and some winter months were colder than average. Hourly values were recorded, but mean monthly values are plotted to show general trends. Interior temperature within the test facility was maintained year round at approximately 21°C (70°F).

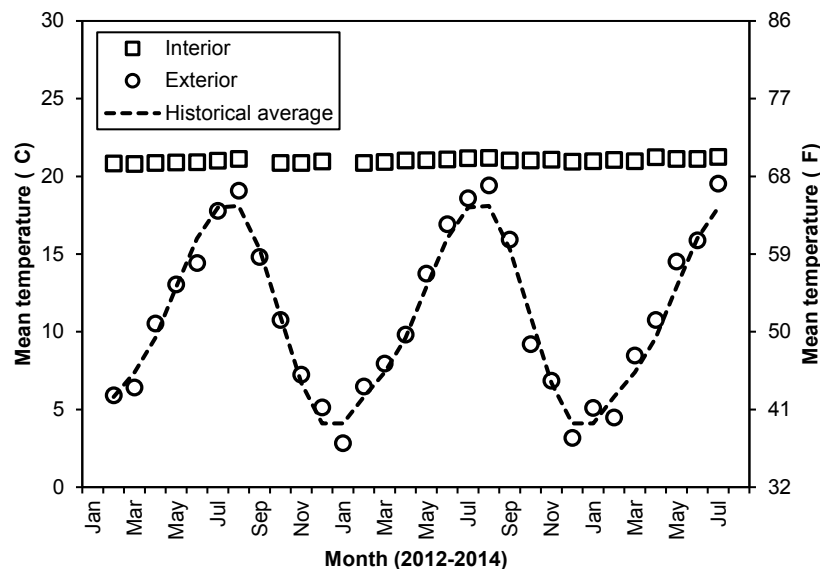

**Figure 4. Monthly mean temperatures measured at NET facility and historical average for Puyallup, Washington**

Precipitation measured onsite over the monitoring period was similar to historical average data, as indicated using monthly cumulative values in Figure 5.

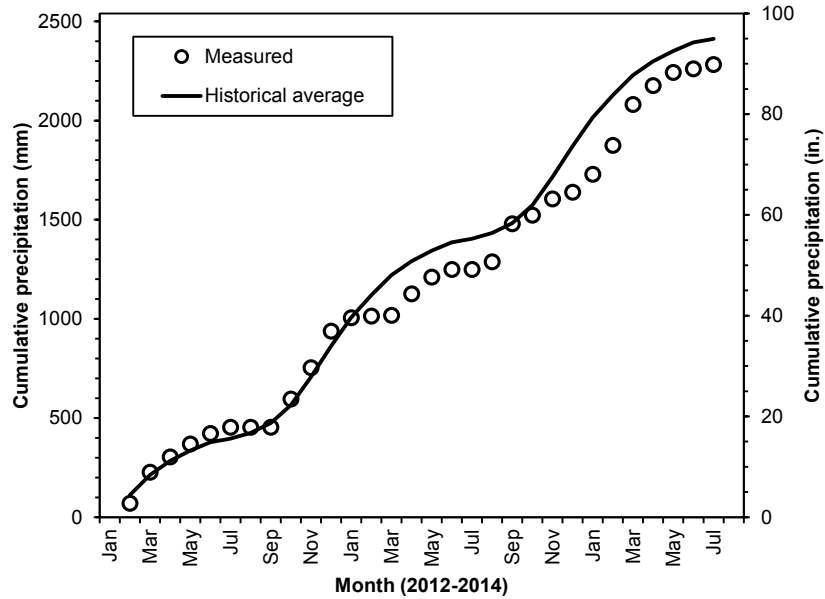

**Figure 5. Cumulative precipitation measured at NET facility and historical average for Puyallup, Washington**

Exterior and interior relative humidity levels are shown in Figure 6. Interior levels were maintained year round at approximately 50% RH, but there were periods during winter when RH levels fell because of brief loss of humidification. The interior RH levels, however, were similar to typical levels in residential buildings in this climate zone (Aoki-Kramer and Karagiozis 2004, Arena et al. 2010).

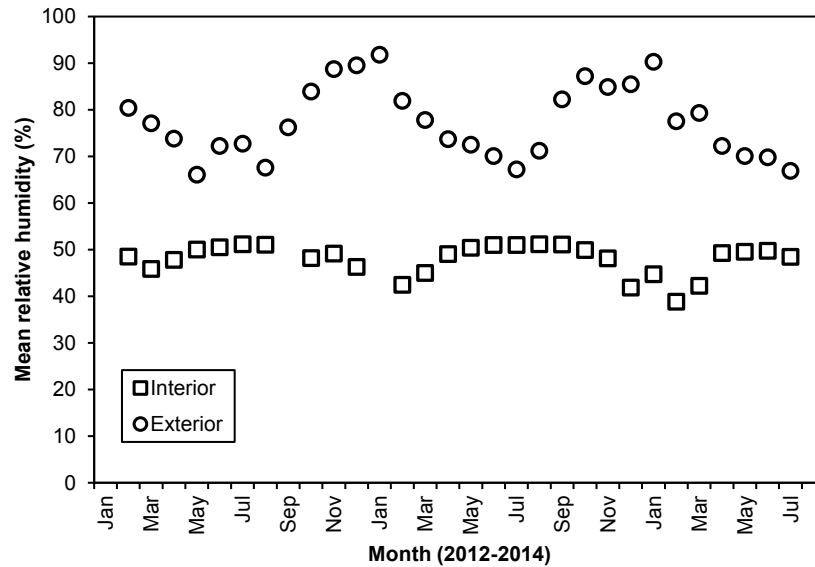

**Figure 6. Monthly mean relative humidity levels measured at NET facility**



**Material property measurements.** Laboratory tests were conducted to measure water vapor permeance and thermal resistance of some of the materials used in construction of the test wall sections. Materials were selected from the same batch of the product that was used to construct wall assemblies.

Test methods for water vapor transmission included the desiccant method (dry cup) and the water method (wet cup) of ASTM E96 (ASTM 2010b). For both methods, an environmental chamber was set at 23°C (73°F) and 50% RH. Specimens were cut to 135 mm × 135 mm (5.3 in. × 5.3 in.); edges were sealed with foil tape and then sealed to a metal dish with wax. Four replicates of each material were tested. Mean values are listed in Table 2. The measurements were in general concurrence with published values (ASHRAE 2013, Kumaran et al. 2002). Literature data for vapor permeance of OSB span a considerable range. The observed increase in vapor permeance from dry cup to wet cup measurements is consistent with previous measurements, and the measured values here fall within the upper part of the range of literature values (Glass 2013).

**Table 2. Vapor permeance measurements**

Material	Thickness, mm (in.)	Vapor Permeance, ng/(Pa·s·m <sup>2</sup> ) (perms)	
		Dry Cup	Wet Cup
Interior gypsum board	12.5 (0.494)	1670 (29.0)	2590 (45.1)
Interior gypsum board, one coat primer and two coats latex paint	12.7 (0.499)	150 (2.6)	470 (8.2)
Oriented strand board	11.8 (0.464)	100 (1.8)	420 (7.3)

Thermal resistance of rigid insulation materials was measured according to ASTM C518 (ASTM 2010a) with a mean temperature of 24°C (75°F). Specimens were 610 mm × 610 mm (24 in. × 24 in.). Six replicates of each material were tested. Specimens were stored in a laboratory maintained at approximately 50% RH prior to testing. Mean values and standard deviations are listed in Table 3. The measured values slightly exceed the manufacturer’s stated nominal R-values (5 h·ft<sup>2</sup>·°F/Btu).

**Table 3. Thermal resistance measurements**

Material	Thickness, mm (in.)	Thermal Resistance, m <sup>2</sup> ·K/W (h·ft <sup>2</sup> ·°F/Btu)
Extruded polystyrene insulation	26.1 (1.03)	0.904±0.003 (5.13±0.02)
Mineral wool insulation	32.7 (1.29)	0.969±0.006 (5.50±0.04)

## **HYGROTHERMAL MODELING APPROACH**

The test wall configurations described above were simulated using WUFI® Pro 5.2 Software (Fraunhofer Institute for Building Physics, Holzkirchen, Germany) for one-dimensional transient heat and moisture transfer (IBP 2013, Künzle and Kiessl 1997). (“WUFI” stands for wärme und feuchtetransport instationär, German for “transient heat and moisture transport”). One-dimensional hygrothermal simulations are sometimes used by practitioners in North America for building envelope design analysis. In such cases actual material properties are not known with precision ahead

of time, and practitioners rely on material properties from the literature or databases incorporated into simulation software. The objective of running these simulations was to evaluate the ability of hygrothermal simulations to predict OSB moisture levels in this climate for these wall assemblies given generic material properties and historic weather data.

Wall configurations are listed in Table 1. Each configuration was modeled as a multi-layer assembly, taking a one-dimensional section through the insulated cavity (rather than the framing). Each configuration was simulated in both north-facing and south-facing orientations. Material properties were assigned from the WUFI North America Database (IBP 2013); many of the properties in this database are taken from the work of Kumaran et al. (2002). Interior primer and paint layers on gypsum board were modeled as an interior surface diffusion resistance based on the mean of the measured dry cup and wet cup vapor permeance values. Vinyl siding was simulated using an equivalent vapor permeance, which is a simple method of modeling a cladding that is vapor impermeable but is back-ventilated by airflow. The equivalent vapor permeance was selected as  $2300 \text{ ng}/(\text{Pa}\cdot\text{s}\cdot\text{m}^2)$  (40 perms) (Glass 2013).

The initial moisture content of OSB was set to correspond with measured mean values in each of the wall assemblies at the beginning of Phase I. For materials other than OSB, the initial moisture content was set at equilibrium with 50% RH. Initial temperature in all materials was set to  $21^\circ\text{C}$  ( $70^\circ\text{F}$ ). Simulations had a start date corresponding to February 1, 2012, a one-hour time step, and an end date corresponding to January 31, 2013.

Interior temperature and relative humidity were set to be constant at  $21^\circ\text{C}$  ( $70^\circ\text{F}$ ) and 50% RH, approximately the same as measured values (Figures 4 and 6). Given that weather parameters measured onsite were similar to historical values, the exterior conditions for simulations were taken from a weather file for Seattle, Washington, built into the simulation software. Wind-driven rain on the walls was calculated according to ASHRAE Standard 160 (ASHRAE 2009), using horizontal rainfall, wind speed, and wind direction from the weather file. A rain exposure factor of 1.0 (medium exposure for buildings less than 10 m (33 ft)) and a rain deposition factor of 0.35 (for walls below a steep-slope roof) were assumed.

Drying behavior of OSB after the first water injection in Phase II was also simulated. In this case the OSB layer was divided into three parts: an outer 3 mm (1/8 in.) layer, a middle 5.8 mm (0.23 in.) layer, and an inner 3 mm (1/8 in.) layer. To simulate wetting of the OSB from the cavity side, the initial moisture content of the inner OSB layer was set to 25% MC, whereas the middle and outer layers were set to 10% MC. The increase from 10% MC to 25% MC roughly corresponds to 300 mL of water being uniformly distributed throughout the inner 3 mm (1/8 in.) of the OSB over the full height and width of the cavity. Simulations were run for north- and south-facing walls with a start date corresponding to March 29, 2013, the last day of the first series of water injections.

## **RESULTS AND DISCUSSION**

The results discussed in this paper are limited to measured and simulated wood moisture contents. Further detail on temperature and relative humidity measurements can be found in the project report (Yeh et al. 2014).

**Measured wood moisture content, Phase I.** The test walls were subjected only to exterior and interior environmental conditions during Phase I; water was not injected into the walls in this phase. Wood moisture contents are plotted for the different sensor locations in each of the four wall assemblies in Figures 7–10. The sensor readings in OSB sheathing in each wall were then averaged so that the four walls could be compared directly, as shown in Figure 11.

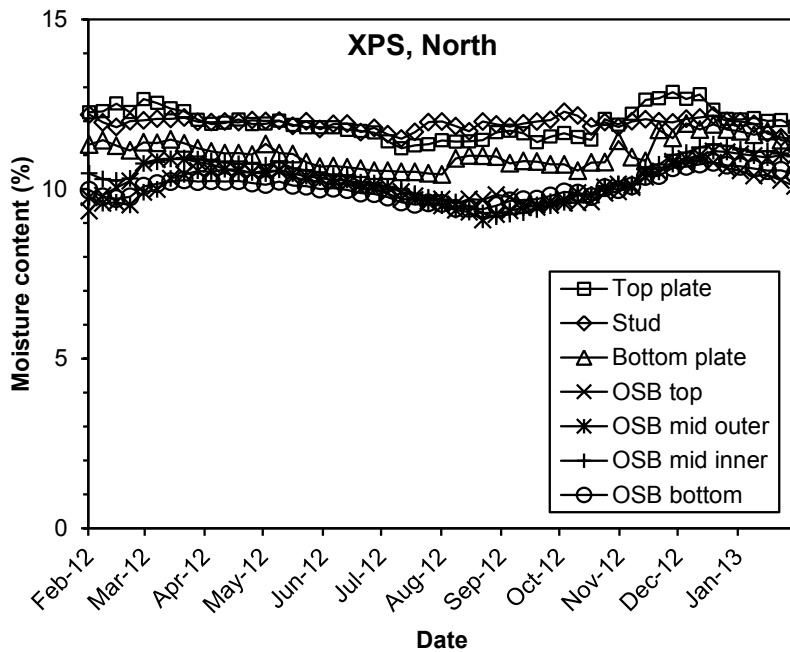

**Figure 7. Measured wood moisture content in Wall N7**

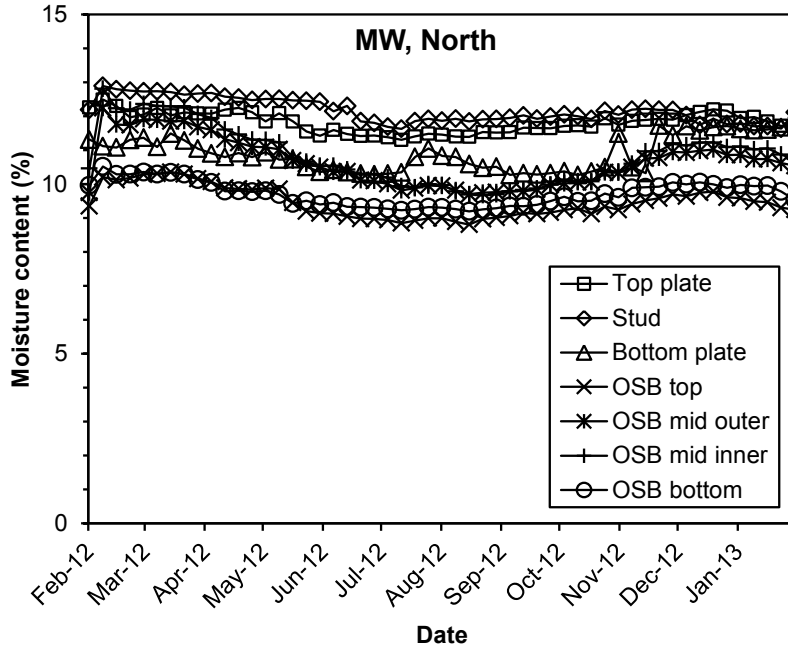

Figure 8. Measured wood moisture content in Wall N8

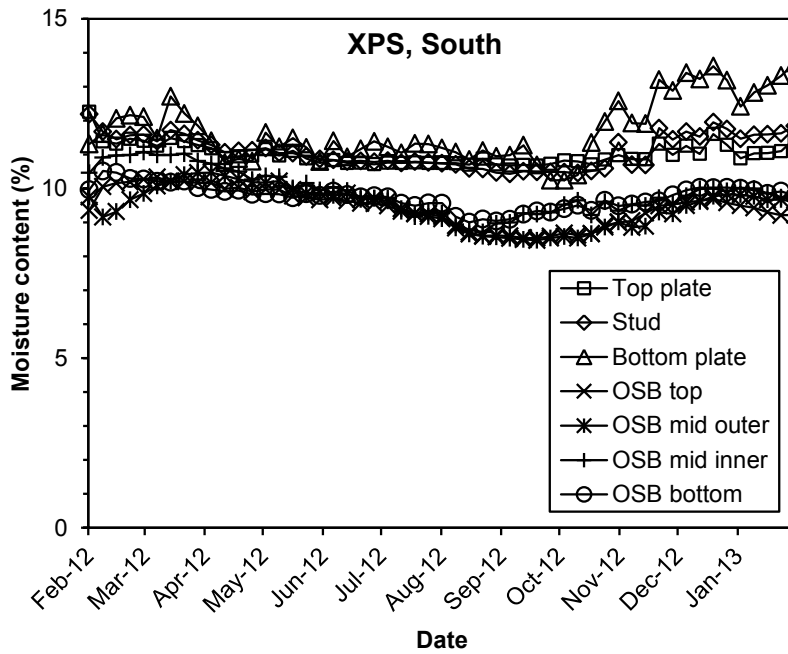
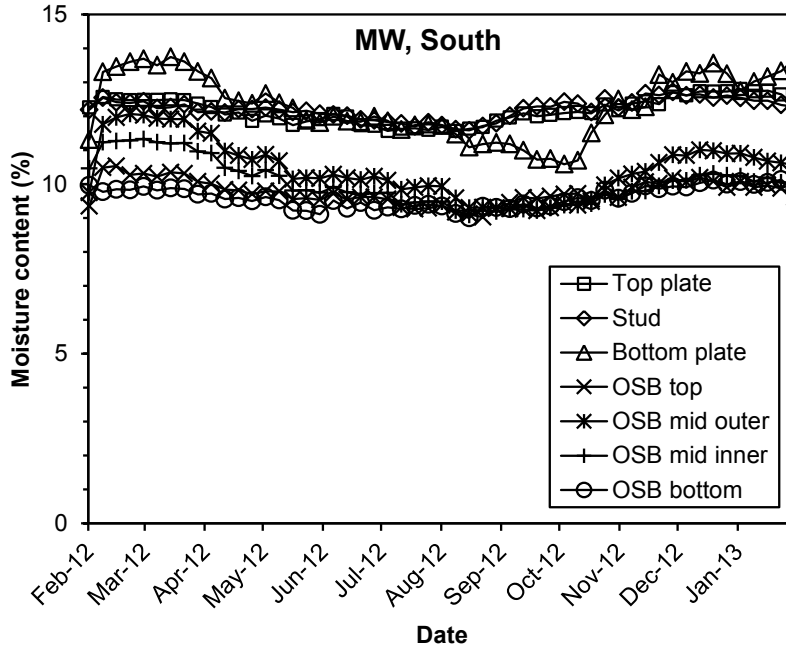
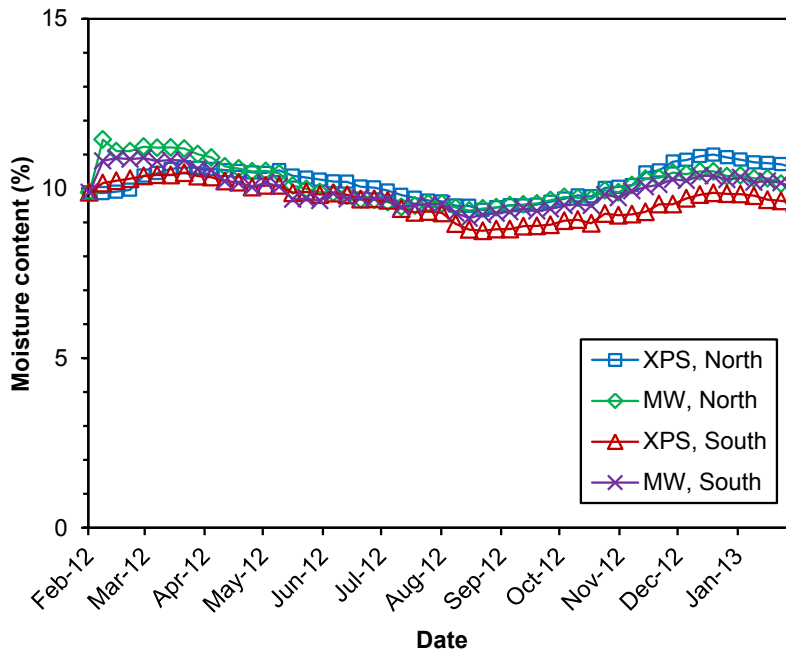

Figure 9. Measured wood moisture content in Wall S11



**Figure 10. Measured wood moisture content in Wall S12**



**Figure 11. Mean OSB moisture content measured in Walls N7, N8, S11, and S12**

In all four walls, wood moisture contents were below 14% MC, well within the range of safe moisture levels. Wall moisture performance was similar to measured values in previous studies in this climate for assemblies with good performance discussed in the Introduction (Tichy and Murray 2007, Smegal et al. 2013). Figures 7-10 indicate that moisture levels in framing generally were higher than those in OSB sheathing. This is a result of the fact that at a given RH level, the equilibrium moisture content

of composite wood products is slightly lower than that of solid wood. Focusing on OSB moisture contents (Figure 11), the effects of wall orientation and exterior insulation were apparently insignificant. These observations are discussed further below in regard to hygrothermal simulations.

The seasonal trend in moisture levels is relatively small. Summer and winter values differ by less than 2% MC typically. For homes in the Pacific Northwest, moisture loading from the exterior and interior environments is most significant in the months of October through March. This is when there is greatest rainfall, highest outdoor humidity, and highest vapor drive from the interior. Drying typically occurs with the transition to warmer, dryer weather in spring and summer.

**Simulated OSB moisture content, Phase I.** OSB moisture contents from hygrothermal simulations for the four walls are compared with measured values in Figure 12. In general, the simulations correctly predicted the approximate magnitude of OSB moisture contents and the slight seasonal trend of higher MC in winter and lower MC in summer. The simulations, however, slightly over-predicted MC values for walls with XPS in winter and under-predicted MC values for all walls in summer (relative to measured values). Exact agreement between measurement and simulation should not be expected given that the simulations are one-dimensional and do not account for possible effects of air leakage, which can have a significant influence on moisture conditions.

Sensitivity analysis (Table 4) indicates that the winter peak MC in walls with XPS depends on the vapor permeance of the paint coating on the interior gypsum board and interior humidity levels. The peak winter OSB moisture content increases with increasing vapor permeance and increasing interior RH. The walls with MW exterior insulation are less sensitive than the walls with XPS exterior insulation because the vapor-open MW allows moisture to pass through the OSB to the exterior more readily. These trends are consistent with previous analysis for similar walls in a mixed-humid climate (Glass 2013).

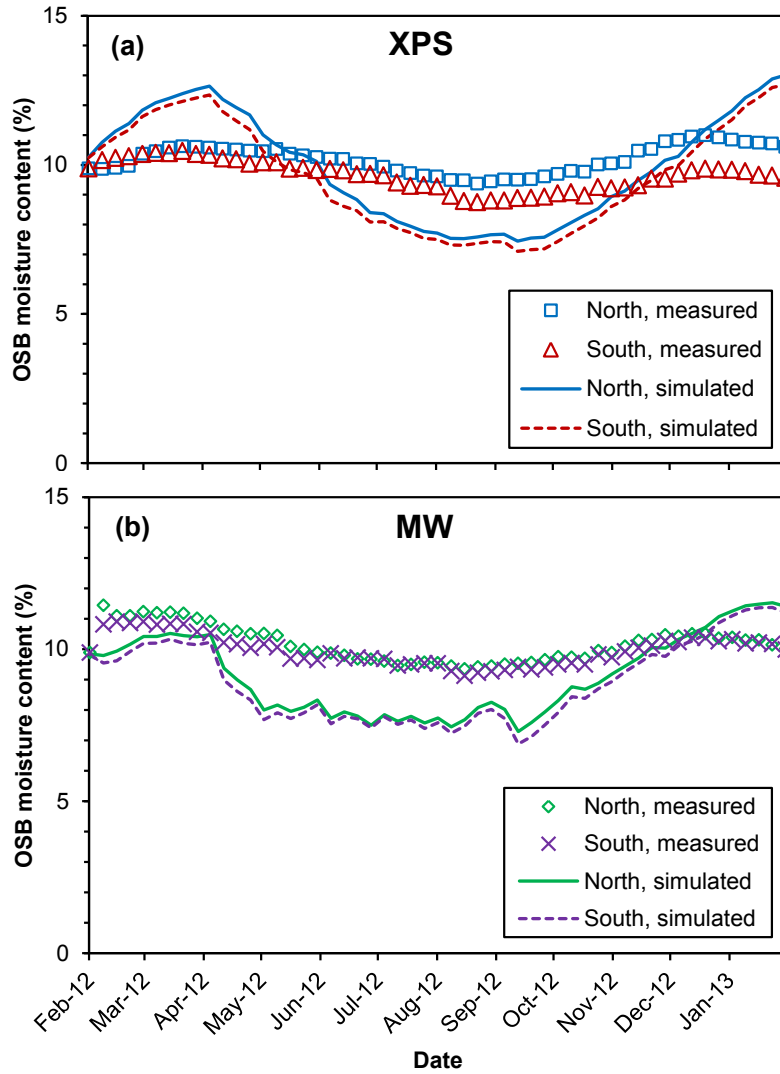
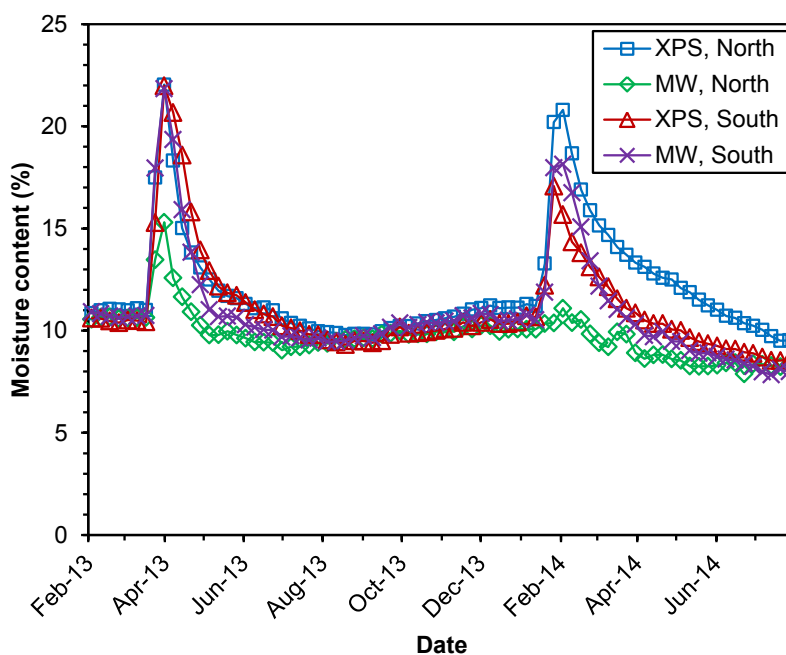

Figure 12. Measured and simulated OSB moisture content in walls with (a) XPS and (b) MW exterior insulation

Table 4. Effects of interior relative humidity and interior vapor permeance on simulated winter peak OSB moisture content in north-facing walls

Exterior Insulation	Interior RH	Interior Paint Vapor Permeance		Winter Peak OSB MC (%)
		ng/(Pa·s·m <sup>2</sup> )	perms	
XPS	50%	290	5	13.1
	55%	290	5	14.9
	50%	570	10	14.4
	50%	1150	20	15.4
MW	50%	290	5	11.6
	55%	290	5	12.6
	50%	570	10	12.5
	50%	1150	20	13.2

**Measured wood moisture content, Phase II.** The wood moisture contents in Phase II were generally similar to those in Phase I except for periods following intentional water injections. As mentioned previously, the water injections were not as consistent as originally envisioned. Water flow rates were found not to be identical between test walls because of variation in the performance of irrigation tubing. In all wall assemblies the bottom plate moisture pins identified significant spikes in moisture content, presumably from injected liquid water running down the OSB sheathing to the bottom plates. The moisture pins in OSB sheathing at mid height and at the bottom also showed increases in moisture content, but were not consistent between the four wall assemblies. The four moisture content readings that were affected by water injections (MC4–MC7 in Figure 3, located in the OSB near the wetting device and the bottom plate and in the bottom plate itself) for each wall are depicted in Figure 13 as weekly average values. After the wetting events, wood moisture contents returned to pre-injection levels at different rates. Drying was typically faster following the first wetting (late March 2013) than the second wetting (late January 2014), presumably because of warmer weather in spring than in winter. The drying rates of the south-facing walls with XPS and MW were similar after both wettings. The drying rates of the north- and south-facing walls with XPS were similar after the first wetting. The north-facing wall with XPS, however, took considerably longer to dry after the second wetting. It is possible that this was a result of more of the injected water reaching the areas where the sensors were placed in this wall. The north-facing wall with MW showed a small response to the first wetting and almost no response to the second wetting, possibly because the injected water did not reach the areas where the sensors were placed.



**Figure 13. Measured moisture content in Walls N7, N8, S11, and S12 (average of readings in bottom plate and in OSB near wetting device and bottom plate)**



**Simulated OSB drying performance.** Simulated moisture contents in the inner and middle layers of the OSB are shown in Figure 14. (The outer layer is not shown in the figure but behaved similarly to the middle layer. The south-facing walls are not shown but were similar to the north-facing walls.) The walls with vapor-tight XPS and vapor-open MW exterior insulation showed similar behavior in the simulations. The minor differences between the two walls suggest that drying to the exterior was not dominant. Within two weeks, the inner layer dropped to about 13% MC (from 25% MC initially), whereas the middle layer increased to about 13% MC (from 10% MC initially) in both walls. This indicates that some of the initial moisture in the inner layer was redistributed into the middle of the OSB. Drying to the interior through the vapor-open fiberglass insulation and gypsum board also occurred. This can be seen by comparing the water vapor pressure at the OSB surface to the vapor pressure inside the building. The temperature of the OSB surface at the start of the simulation was about 12°C (54°F); saturation vapor pressure at this temperature is 1407 Pa. The interior vapor pressure (corresponding to 21°C (70°F) and 50% RH) was 1248 Pa, so there was a vapor pressure gradient from the OSB to the interior. Although these simulations are one-dimensional and are not intended to capture the full behavior of the actual water injections, the simulations do provide some insight into the drying and redistribution mechanisms. Further experimental and modeling work is recommended to better understand and quantify redistribution and inward and outward drying in walls with various types of exterior insulation.

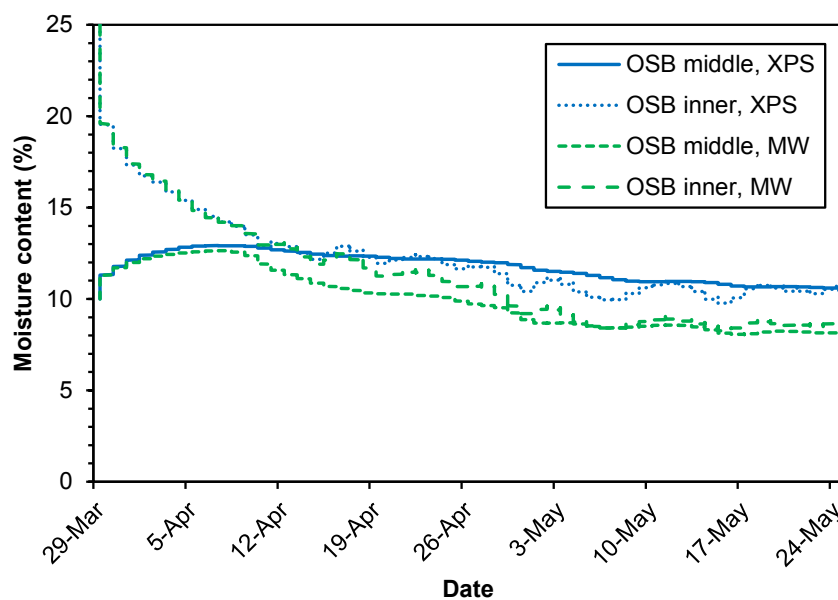

**Figure 14. Simulated moisture content in middle and outer OSB layers in north-facing walls with wetting occurring in late March**

## CONCLUSIONS

Moisture and temperature conditions were measured in north- and south-facing exterior walls of a test facility in Puyallup, Washington (IECC Climate Zone Marine 4) over a two-year period. The wall assemblies included interior gypsum board with latex primer and paint, 2×4 framing with nominal R-13 batt insulation, 11 mm (7/16

in.) oriented strand board, nominal R-5 exterior insulation consisting of either extruded polystyrene or mineral wool, and vinyl siding.

Measurements indicated that walls with extruded polystyrene and mineral wool exterior insulation performed similarly in both north and south orientations. In all four walls, wood moisture contents were below 14% MC, well within the safe range for long-term durability. The seasonal trend in moisture levels was relatively small; summer and winter values differed by less than 2% MC typically.

Hygrothermal simulations correctly predicted the approximate magnitude of OSB moisture contents and the slight seasonal trend of higher MC in winter and lower MC in summer. The simulations, however, slightly over-predicted MC values for walls with XPS in winter and under-predicted MC values for all walls in summer (relative to measured values).

Intentional water injections into the wall cavities were conducted to evaluate the rate of drying under natural conditions. The quantity of water and distribution of wetting, however, were not consistent between the four wall assemblies, precluding direct comparisons of drying potential. Nonetheless, wood moisture contents returned to pre-injection levels within 4 to 6 weeks after the wetting events in all four wall assemblies. Further work is recommended to provide insight into moisture redistribution and drying mechanisms in wood-frame walls with exterior insulation.

### **ACKNOWLEDGMENTS**

The authors thank Dr. Bob Tichy, Mr. Chris Fuess, and Dr. Robert Duncan of Washington State University for their contributions to this project. This work was a joint research project between APA – The Engineered Wood Association, the USDA Forest Products Laboratory, and the Washington State University. This research was supported in part by funds provided by the USDA Forest Products Laboratory through the Coalition for Advanced Wood Structures (CAWS).

### **REFERENCES**

- Aoki-Kramer, M., and Karagiozis, A.N. (2004). "A New Look at Residential Interior Environmental Loads," *Performance of Exterior Envelopes of Whole Buildings IX International Conference Proceedings*, December 5–10, 2004, Clearwater Beach, FL.
- Arena, L.B., Karagiozis, A., and Mantha, P. (2010). "Monitoring of Internal Moisture Loads in Residential Buildings—Research Findings in Three Different Climate Zones," *Thermal Performance of the Exterior Envelopes of Whole Buildings XI International Conference Proceedings*, December 5–9, 2010, Clearwater Beach, FL.
- ASHRAE. (2009). *ANSI/ASHRAE Standard 160–2009, Criteria for Moisture-Control Design Analysis in Buildings*, American Society of Heating, Refrigerating and Air-Conditioning Engineers, Inc. Atlanta, GA.

- ASHRAE. (2013). "Heat, Air, and Moisture Control in Building Assemblies—Material Properties," In: *2013 ASHRAE Handbook—Fundamentals*, Chapter 26. American Society of Heating, Refrigerating and Air-Conditioning Engineers, Inc. Atlanta, GA.
- ASTM. (2010a). *ASTM C518–10, Standard Test Method for Steady-State Thermal Transmission Properties by Means of the Heat Flow Meter Apparatus*. ASTM International. West Conshohocken, PA.
- ASTM. (2010b). *ASTM E96/E96M–10, Standard Test Methods for Water Vapor Transmission of Materials*. ASTM International. West Conshohocken, PA.
- Desjarlais, A.O., Karagiozis, A.N., and Aoki-Kramer, M. (2001). "Wall Moisture Problems in Seattle," *Performance of Exterior Envelopes of Whole Buildings VIII International Conference Proceedings*, December 2–7, 2001, Clearwater Beach, FL.
- Glass, S.V. (2013). *Hygrothermal Analysis of Wood-Frame Wall Assemblies in a Mixed-Humid Climate*, Research Paper FPL–RP–675. U.S. Department of Agriculture, Forest Service, Forest Products Laboratory. Madison, WI.
- IBP. (2013). *WUFI® Pro version 5.2*. Fraunhofer Institute for Building Physics. Holzkirchen, Germany. <https://wufi.de/en/>, Visited site on 9/19/2015.
- ICC. (2015a). *International Energy Conservation Code*, International Code Council. Country Club Hills, IL.
- ICC. (2015b). *International Residential Code for One- and Two-Family Dwellings*, International Code Council. Country Club Hills, IL.
- Kumaran, M.K., Lackey, J.C., Normandin, N., Tariku, F., and van Reenen, D. (2002). *A Thermal and Moisture Transport Property Database for Common Building and Insulating Materials: Final Report from ASHRAE Research Project 1018-RP*. American Society of Heating, Refrigerating and Air-Conditioning Engineers, Inc. Atlanta, GA.
- Künzel, H.M., and Kiessl, K. (1997). "Calculation of Heat and Moisture Transfer in Exposed Building Components," *International Journal of Heat and Mass Transfer*, Vol. 40, pp. 159–167.
- Lstiburek, J.W. (2004). "Understanding Vapor Barriers," *ASHRAE Journal*, Vol. 46, No. 8, pp. 40–50.
- Lstiburek, J.W. (2013). "Joni Mitchell, Water & Walls," *ASHRAE Journal*, Vol. 55, No. 8, pp. 72–80.
- Smegal, J., and Straube, J. (2011). *Hygrothermal Analysis of Exterior Rockwool Insulation*, Research Report 1104. Building Science Press. Somerville, MA.

- Smegal, J., Lstiburek, J., Straube, J., and Grin, A. (2013). "Moisture-Related Durability of Walls with Exterior Insulation in the Pacific Northwest," *Thermal Performance of the Exterior Envelopes of Whole Buildings XII International Conference Proceedings*, December 1–5, 2013, Clearwater Beach, FL.
- Straube, J. (2011). *Controlling Cold-Weather Condensation Using Insulation*, Building Science Digest 163. Building Science Press. Somerville, MA.
- Straube, J., Onysko, D., and Schumacher, C. (2002). "Methodology and Design of Field Experiments for Monitoring the Hygrothermal Performance of Wood Frame Enclosures," *Journal of Thermal Envelope & Building Science*, Vol. 26, No. 2, pp. 123–151.
- TenWolde, A., and Rose, W.B. (1996). "Moisture Control Strategies for the Building Envelope," *Journal of Thermal Insulation and Building Envelopes*, Vol. 19, pp. 206–214.
- Tichy, R., and Murray, C. (2007). *Developing Innovative Wall Systems that Improve Hygrothermal Performance of Residential Buildings*, Final Report to U.S. Department of Energy. Washington State University, [http://energy.wsu.edu/Documents/WSU\\_Hygrothermal\\_Final.pdf](http://energy.wsu.edu/Documents/WSU_Hygrothermal_Final.pdf), Visited site on 9/18/2015.
- Tsongas, G.A. (1991). "The Effect of Exterior Insulating Sheathing on Wall Moisture," In: Graves, R.S., and Wysocki, D.C., eds., *Insulation Materials: Testing and Application*, Vol. 2, pp. 401–414. American Society for Testing and Materials. Philadelphia, PA.
- U.S. Department of Energy. (n.d.). *Climate Zones*, <http://energy.gov/eere/buildings/climate-zones>, Visited site on 9/18/2015.
- Yeh, B., Herzog, B., and Glass, S. (2014). *Wood Structural Panel and Foam Insulation Systems: Hygrothermal Behavior and Lateral Load Resistance – Experimental Studies*, Final Report. Form No. R700. APA – The Engineered Wood Association. Tacoma, WA.